

CCTV Project Map UP Mindanao

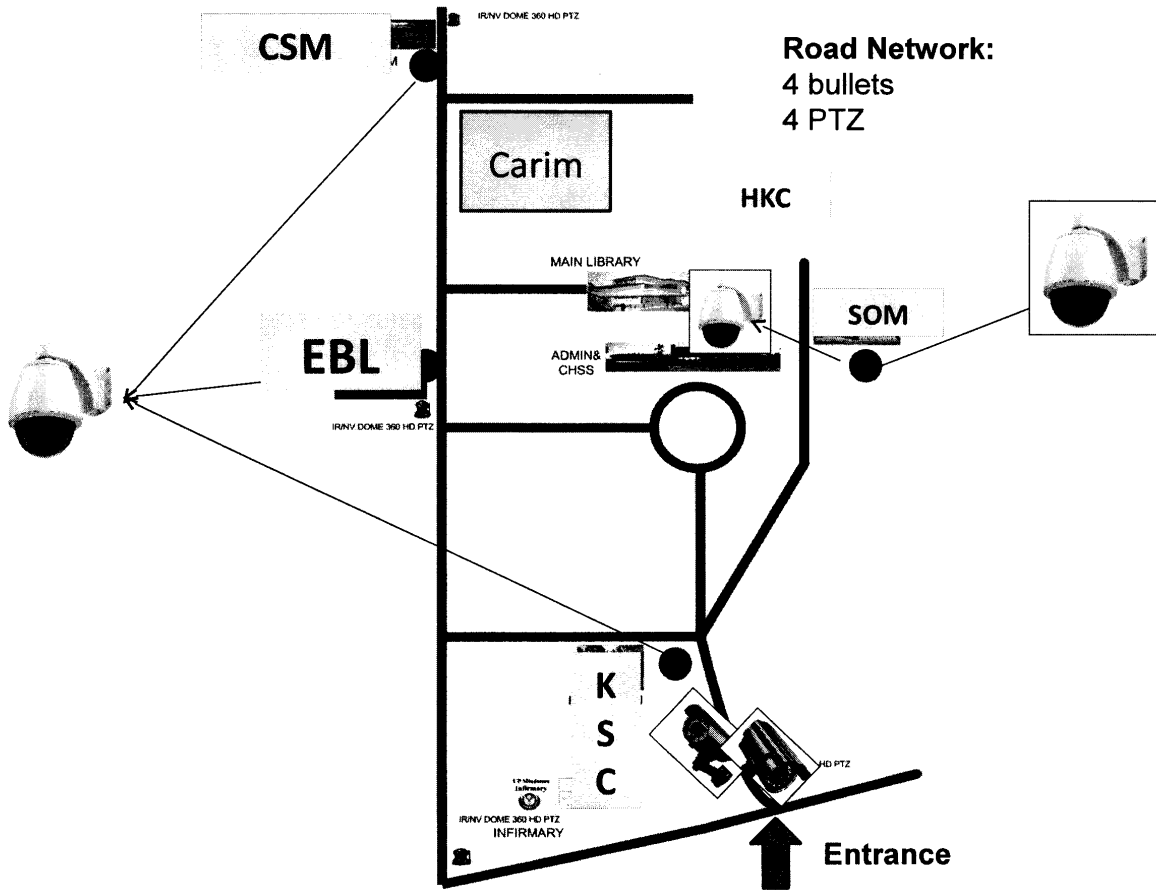

CHSS & Admin 1/F:

1. 1 PTZ
2. 5 Bullet
3. 8 Dome half spherical indoor

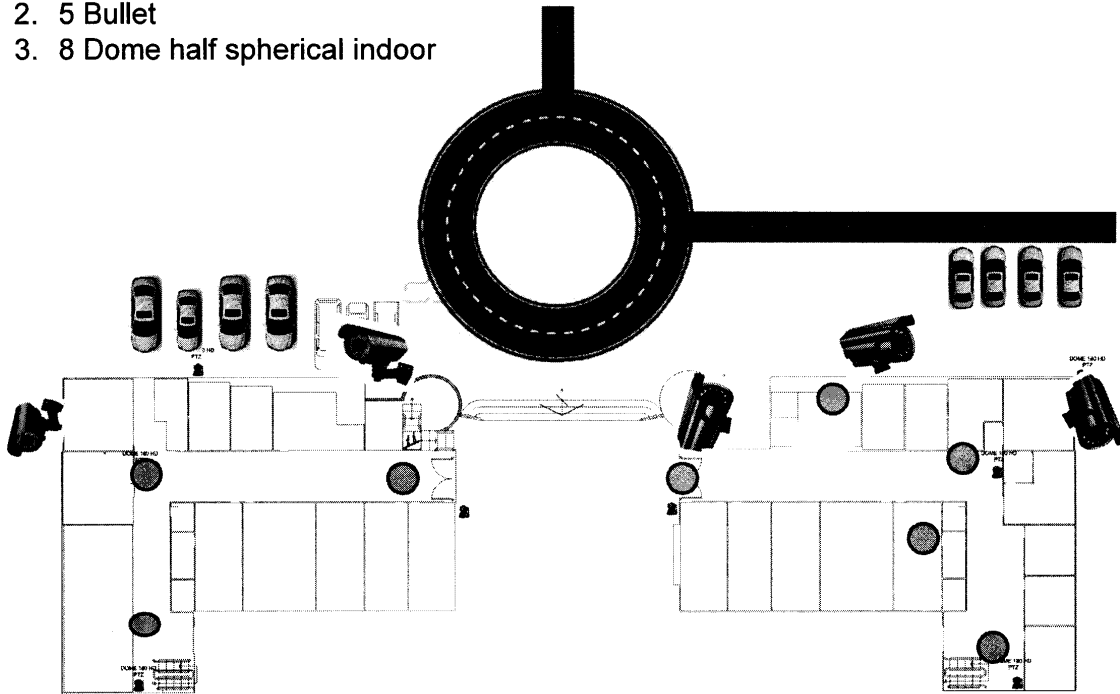

CHSS & Admin 2/F:

- 1. 8 Dome half spherical indoor

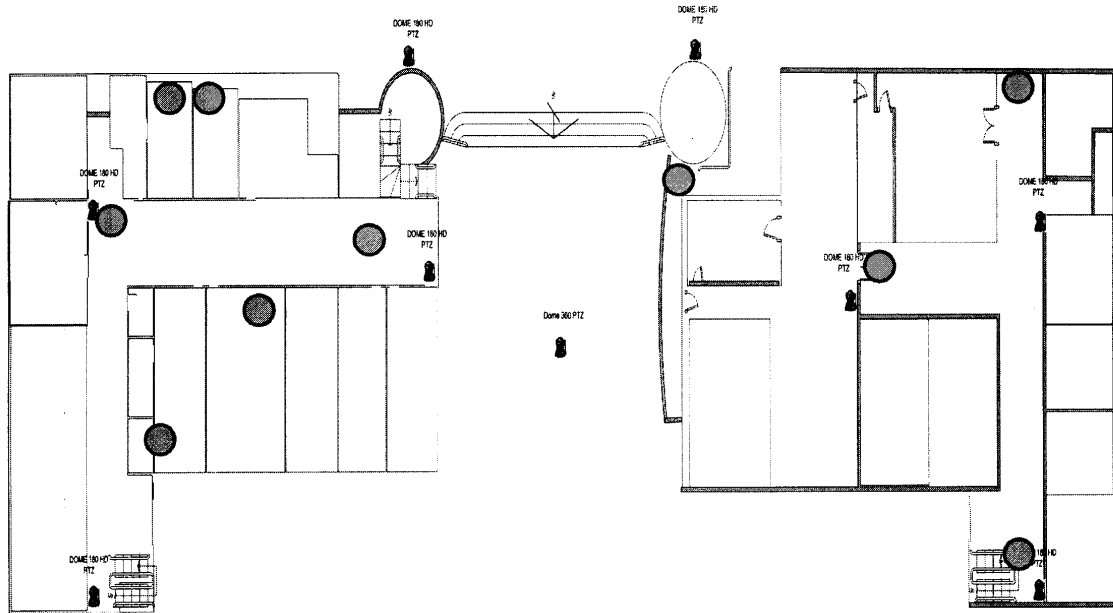

2/F Admin Building

CHSS & Admin 3/F:

- 1. 2 Dome half spherical indoor

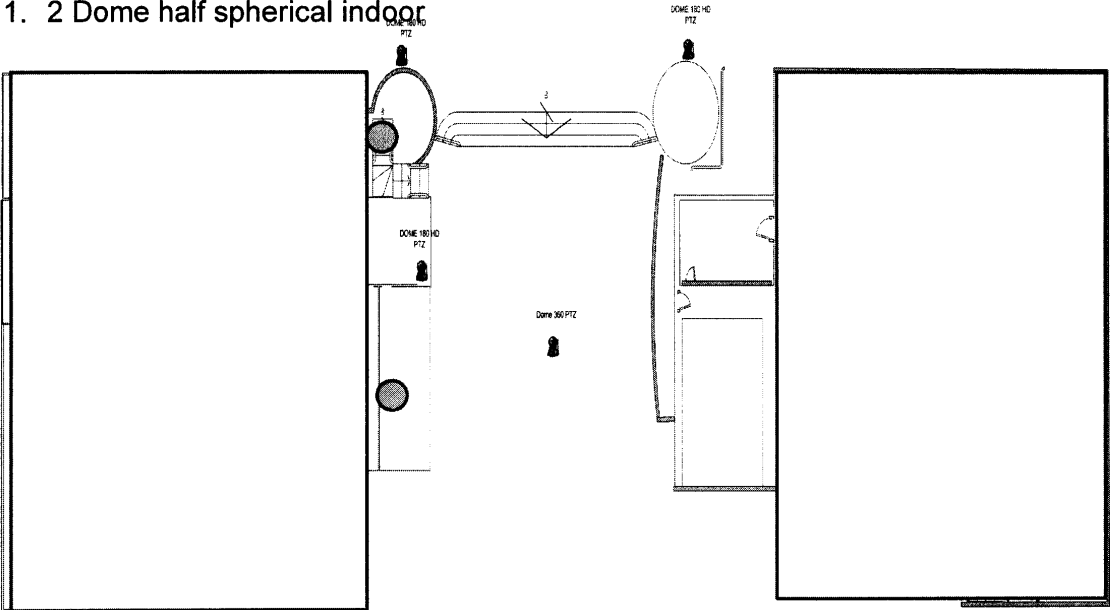

3/F Admin Building

School of Management:

1. 2 Dome half spherical indoor
2. 3 bullet camera
3. Dome 360° outdoor

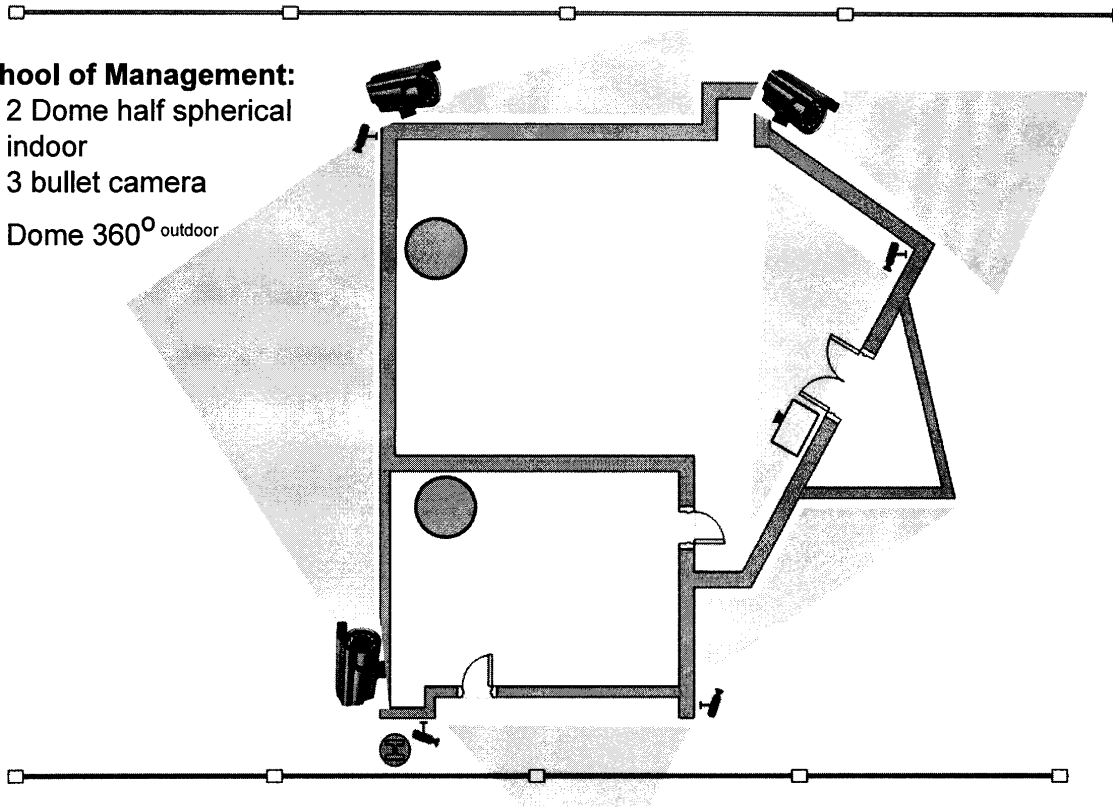

DOME 360 HD PTZ



80 HD PTZ



Human Kinetics Center

HK Center

1. 2 bullet camera outdoor
2. 1 Dome, indoor, half spherical

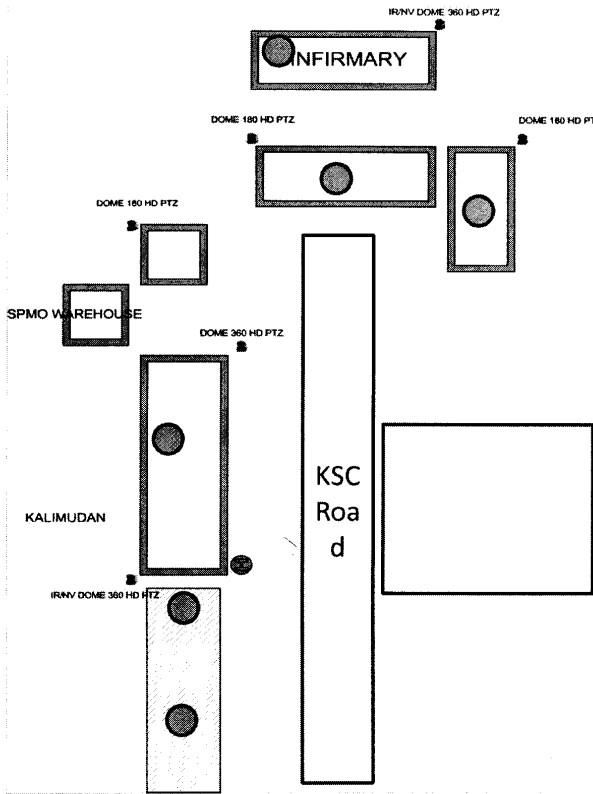

KSC Area Requirements:
1. 6 Dome, indoor, half spherical

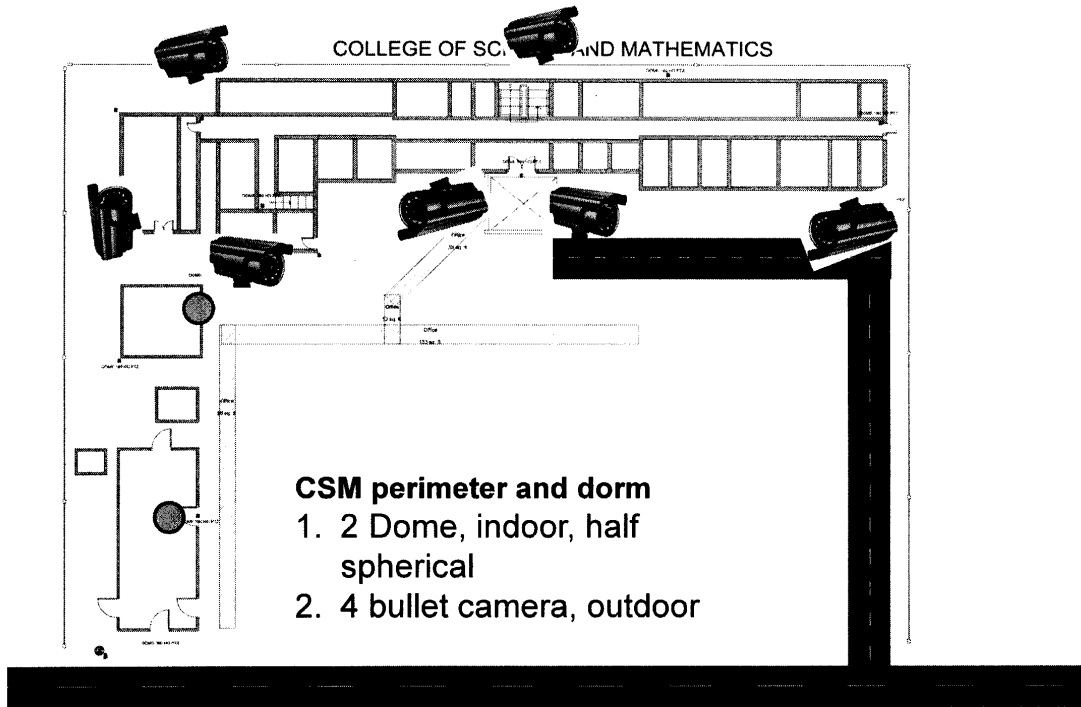

CSM Ground & Perimeter Areas

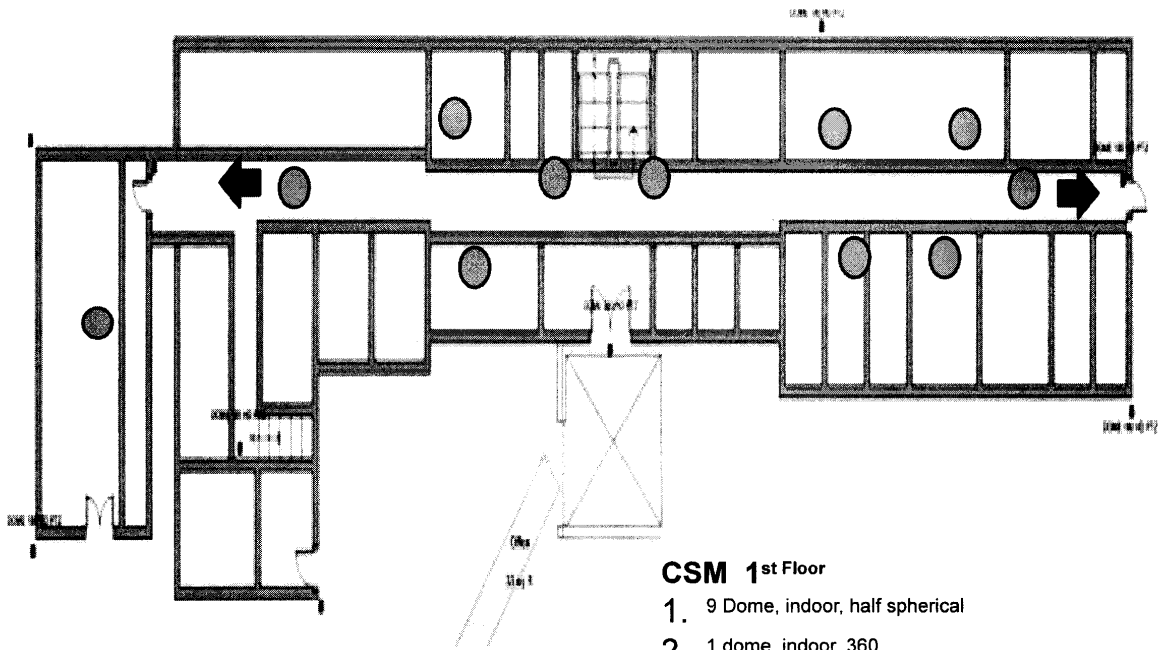

1/F CSM Building

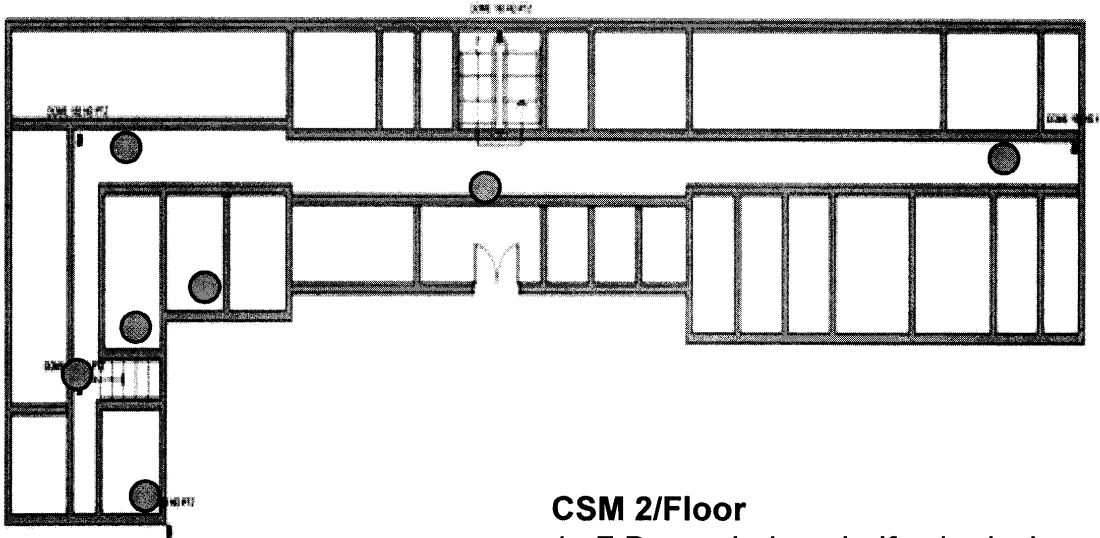

CSM 2/Floor

1. 7 Dome, indoor, half spherical

2/F CSM Building

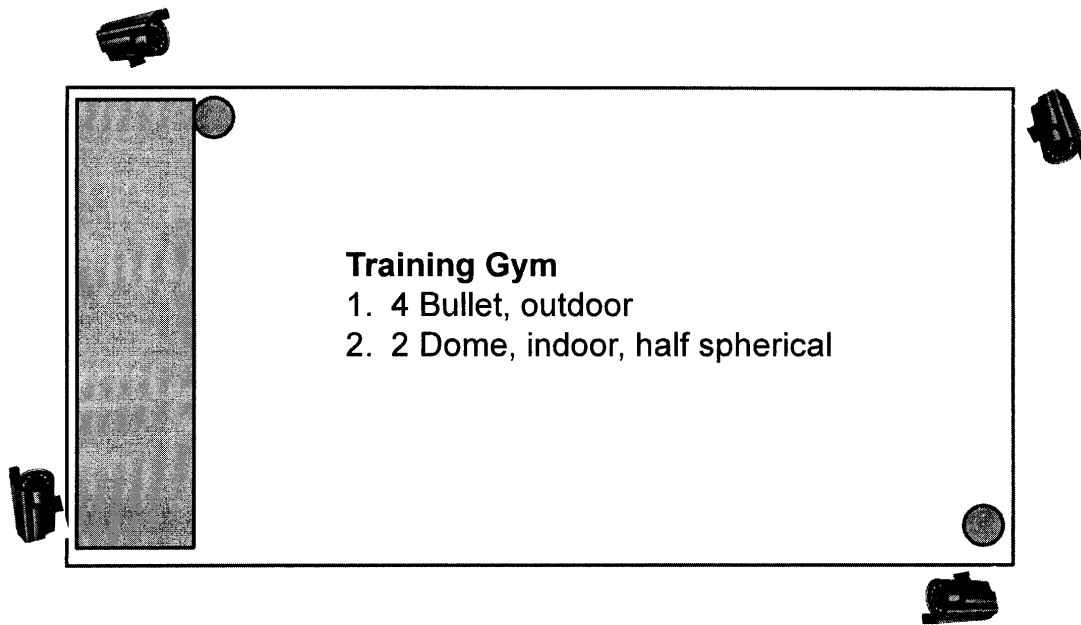

Training Gym, Sports Complex

University of the Philippines Mindanao
Information Technology Office

CCTV PROJECT

Location	TOTAL			Priority			Role
	Bullet (>=120 deg angle)	PTZ (Outdoor)	Dome (half sp, Indoor)	Bullet (>=120 deg angle)	PTZ (Outdoor)	Dome (half sp, Indoor)	
1. Road Network							
Main gate	2				1		1
KSC – Univ. Ave.		1		2			1
R2 Guard Station		1			1		1
CSM Canteen		1			1		1
2. CHSS							
Perimeter	5			5			
Atrium		1			1		
CHSS 1/F			3			3	
CHSS 2/F			6			6	
CHSS 3/F			2			2	
3. Admin							
Admin 1/F			5			5	
Admin 2/F			4			4	
3. SOM & HKC							
Inside the Bldg			2			2	
Perimeter		1			1		1
Perimeter	3			3			
4. Human Kinetics Building							
Perimeter	2						
Perimeter			1				
5. KSC and Infirmary							
KSC and infirmary			6			2	
6. CSM and Dorm							
Perimeter	7			3			
Dorm			2				
CSM 1/F			11			7	
CSM 2/F			7			7	
7. Sports Gym							
Perimeter	4						
Inside the gym			2			2	
Total =	23	5	51	13	5	40	5
		79					